



COVE LIGHTING

APPLICATION NOTE



 LINEAR
 MODULAR
 INFINITE

COVE LIGHTING

How does cove lighting enhance a space?

Cove lighting being an indirect lighting application, helps create an ambient glow in the space purely with reflected lighting. This is soothing to the eyes and does not draw attention onto itself. It also creates less contrast in the space while increasing the overall light levels.

With linear LED lighting sources, cove lighting solutions are becoming more efficient and brighter, substituting the need for downlights in many cases. The smaller cross section of linear LEDs creates opportunities for coves even in very tight cove spaces.

Which parameters have to be carefully evaluated?

- Uniformity of the cove light
- Extent of light throw
- Soft gradation of light to dark
- No hot spots
- Good cove construction

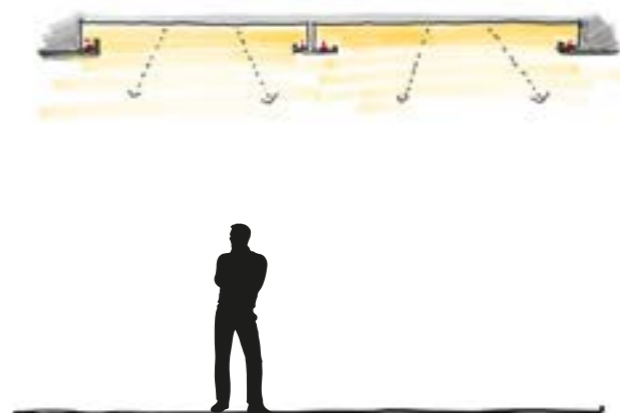



PRODUCT OVERVIEW

XOOCOVE IP40

XOOCOVE IP40 is a unique product developed specially for cove lighting applications. It is available with a diffuse cover or with a 60° lens. A circular profile with a diameter of only 20 mm and six standard lengths allow flexible placement of the luminaire even if space is limited. Tool free mounting is possible through a silicon mounting pad which just has to be put into the cove. The cabling is simplified by connectors which can be pierced everywhere on the main 24 V bus cable making it very easy to feed power into the line. This allows a connection of multiple fixtures up to 10 m with only one cable.

IP40, available with silicon mounting pads or clips.

Suitable applications:
Retrofit cove solutions;
Complex cove constructions – best for straight runs



HYDRALUX™ IP67

HYDRALUX™ is the slimmest, flexible, linear LED light line that can be used in cove applications, which can be cut on site to the desired length depending on the step measurement and then easily be assembled with clips. The sophisticated concept, the minimum bending radius of only 30 mm and the small cross section of 12.5 mm x 3.5 mm allows the use of this tape light virtually anywhere - both indoors and outdoor ceiling locations. Lumen outputs up to 1,650 lumen / meter are possible.

IP67, mounted with clips. Available with IP67 connectors.

Suitable applications:
Straight runs as well as curving ceilings



VarioContour 1924 with LUMINARIS ECO P23 and opal low square cover

This solution is part of the Mix & Match* portfolio and a cost effective combination of tape, profile and cover for cove lighting since the luminaire will be assembled directly at the construction site. LUMINARIS ECO P23 tape offers a maximum lumen output of 2,250 lm/m, and a maximum single run length of 14 meter. The opal cover spreads the light with a beam angle of 120° and gives the cove a smooth touch.

IP40, with end caps, cover, profiles, clips or mounting profile.

Suitable applications:
Budget solution for straight runs



* Mix & Match is a DIY (do-it-yourself) solution of small profiles with high performance, different covers, and mounting options as well as a range of the tape portfolio. Mix & Match offers over 600,000 possible combinations.



XOOCOVE, with silicon mounting pads
Photo: Derek Hudson

APPLICATION IDEA

1st method of using cove lighting –
at ceiling centre

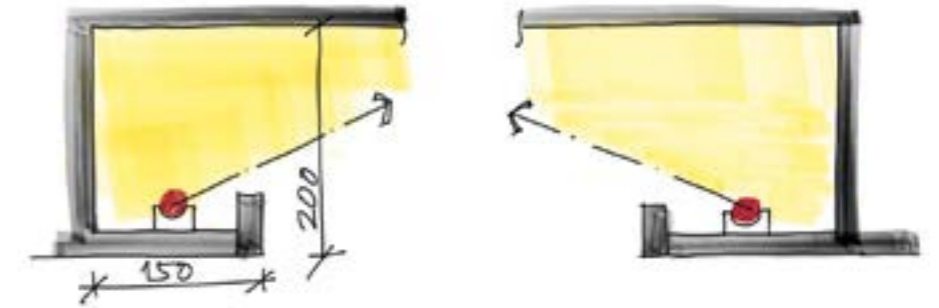

Two-sided cove applications are recommended for areas such as passage-ways and circulation zones. With a two-sided cove application, the use of downlights can be mostly avoided.

Tool-free cove mounting

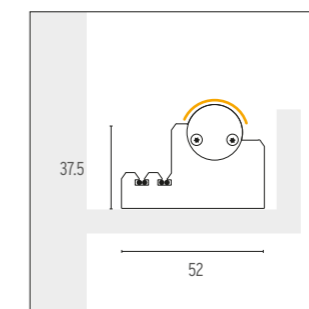

Mounting accessories



XOOCOVE Silicon mount
Art.-#: 13000226

Description

Totally tool free installation of silicon mounting pad, 2 pads per meter are recommended.

All dimensions in mm.

www.led-linear.com/xoocove





HYDRALUX™ IP67 with adhesive tape
Photo: Florian Bouvet Fournier

APPLICATION IDEA

2nd method of using cove lighting –
straight run coves in floating ceiling

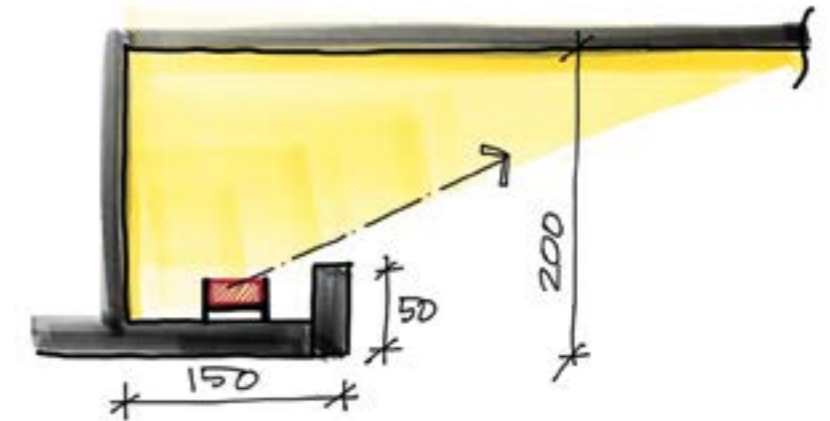

Field cuttable LED light line with minimum cross section size installed as a classic cove detail. Sufficient ambient illumination from reflected light and no dark spots in between.

Surface-mounted

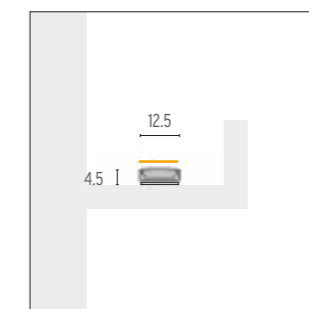

Mounting accessories



3M Adhesive tape
Art.-#: 182000035

Description

Double sided 3M adhesive tape roll.
Use to mount products on surfaces.

All dimensions in mm.

www.led-linear.com/hydralux





VarioContour 1924 with LUMINARIS ECO P23 with clips
Photo: David Wakely Photography

APPLICATION IDEA

3rd method of using cove lighting –
at edge of ceiling

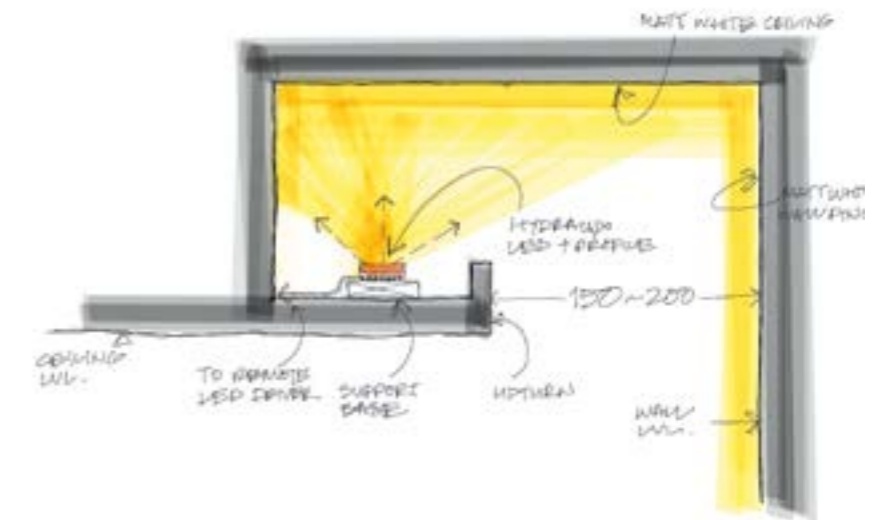

For office lobby areas, a perimeter cove around a special finish ceiling makes a clean and smart space. This simple and minimalist approach is highly recommended for soft indirect light on the side walls to reflect back towards the center of the lobby. It is also a cost effective solution when such lobby spaces are duplicated at each level of an office or a hotel tower.

Surface-mounted

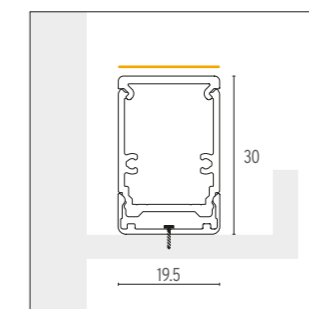

Mounting accessories

VarioClip 19 0°
Art. #: 10000040-01

Description

90 mm anodized aluminum clip,
recommended to use two clips per meter.

All dimensions in mm.

To specify out of the Mix & Match portfolio
please try out our online configurator
www.led-linear.com/mix&match/





XOOCOVE with clips
Photo: David Wakely Photography

APPLICATION IDEA

4th method of using cove lighting –
ceiling and vertical wall plane

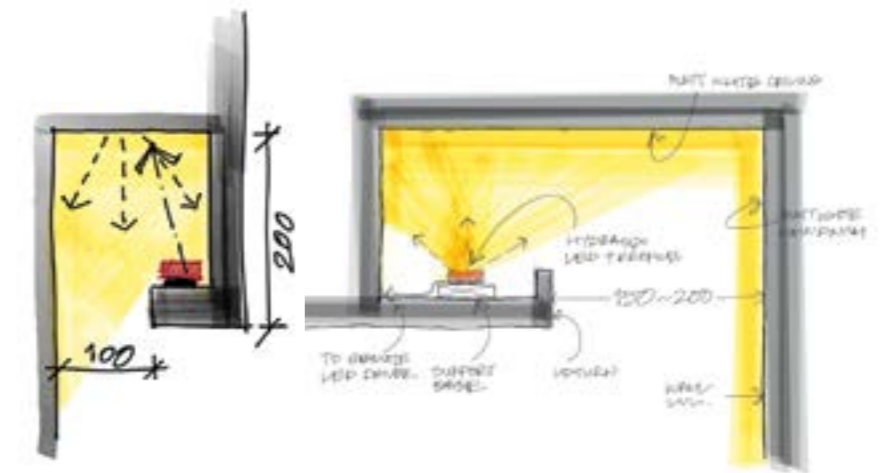

2 different cove applications - one on the ceiling and the other on the vertical plane of the wall, create a contemporary scheme without any downlights and yet fill the space with a pleasing light, without any shadow zones.

Fastened cove mounting

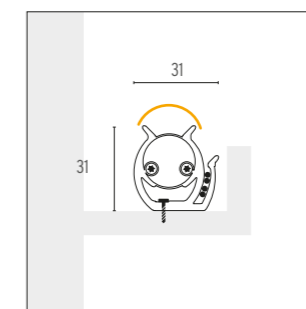

Mounting accessories

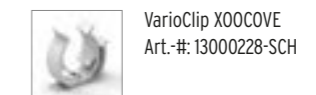

VarioClip XOOCOVE
Art.-#: 13000228-SCH

Description

Plastic mounting clips with special cable groove on the side to simplify the wiring. Recommended to use 2 per meter.



All dimensions in mm.

www.led-linear.com/xoocove



HYDRALUX™ with clip fixing
Photo: Adam Mørk

APPLICATION IDEA

5th method of using cove lighting –
curving edge of ceiling

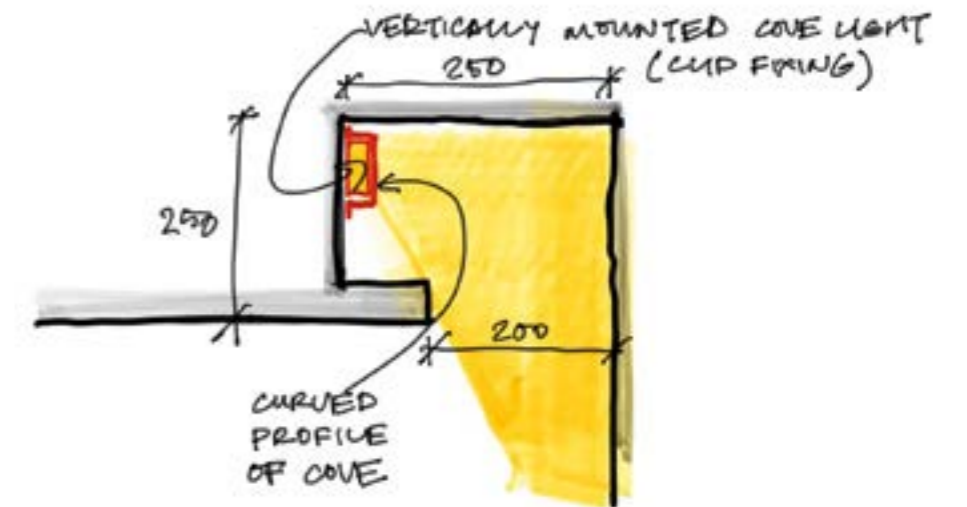

LED light lines following a curving cove can be fixed with transparent clips to maintain the curve. The result is a soft continuous light without any shadow spots.

Surface-mounted

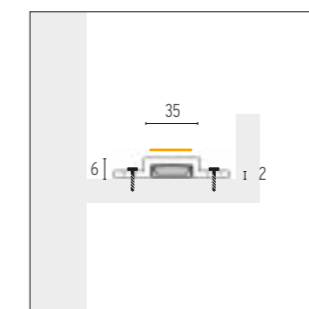

Mounting accessories



VarioClip Flex 12.5 mm
Clear (Set of 50)
Art. #: 13000115

Description

Clear plastic mounting clips. Use to mount the product on hard surfaces. Sold as set of 50 pieces.

All dimensions in mm.

www.led-linear.com/hydralux





VarioContour 1924 with LUMINARIS ECO P23 with VarioClip 19 0° plastic

APPLICATION IDEA

6th method of using cove lighting – horizontal coves on the wall plane

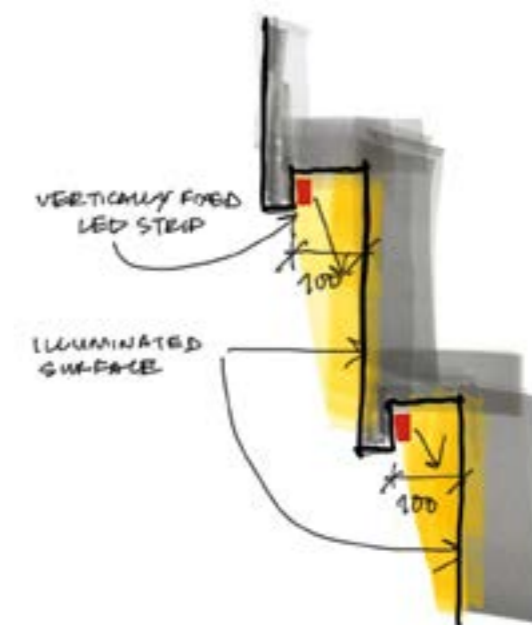

Cove installations on a wall following wall profiles create an interesting light effect in which both architectural edge and people get highlighted.

Wall-mounted

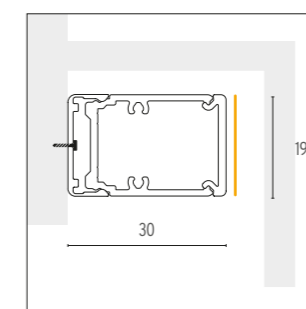

Mounting accessories

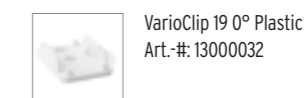

VarioClip 19 0° Plastic
Art.-#: 13000032

Description

Plastic clip for vertical and horizontal use, recommended to use two clips per meter.

All dimensions in mm.

To specify out of the Mix & Match portfolio please try out our online configurator
www.led-linear.com/mix&match/



TECHNICAL DATA

General data

	XOOCOVE IP40	HYDRALUX™ IP67	VarioContour 1924 with LUMINARIS ECO P23
Ingress protection	IP40	IP67	IP40
CRI	up to 96	up to 96	up to 83
Efficiency	up to 121 lm/W	up to 110 lm/W	up to 44 lm/W
Cross section	∅ 20 mm	12.5 mm x 3.5 mm	19.5 mm x 32.1 mm

Color temperature (Kelvin)

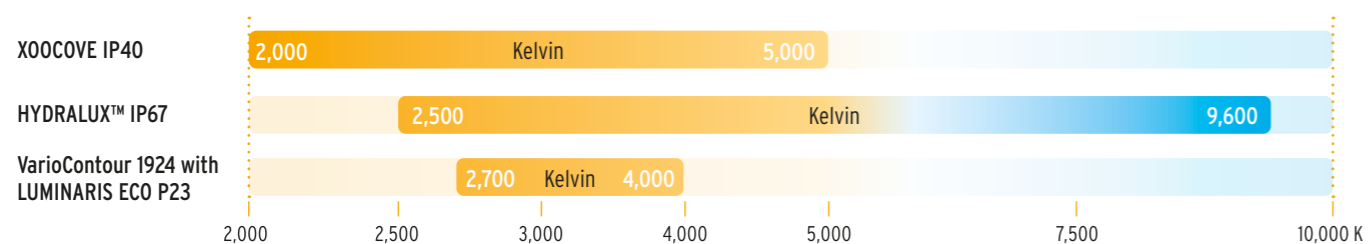

Luminous flux (Lumens per meter)

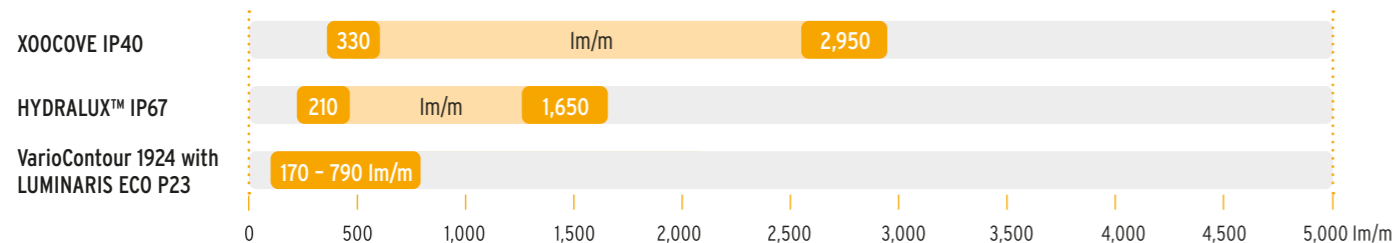

Length (mm)

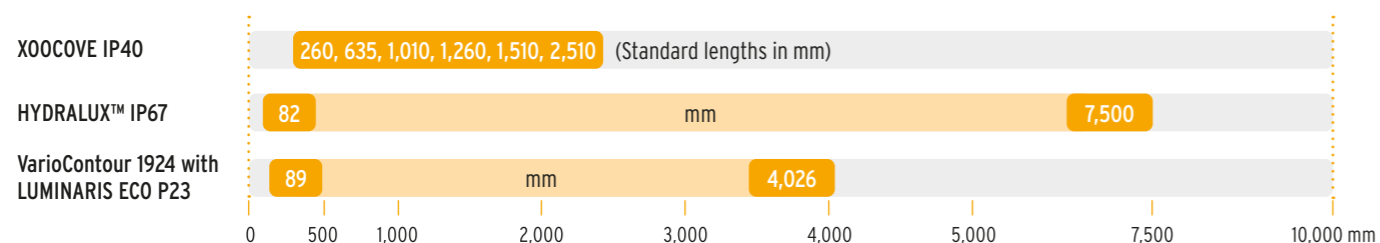

LIGHTING SIMULATION

XOOCOVE IP40

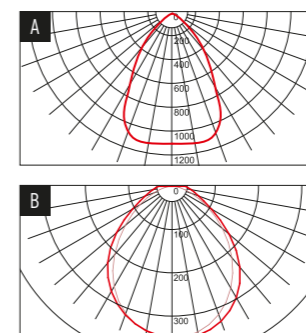

The ease of installation, 360° rotation possibility due to the round profile on the silicon pads, and easy power feed make XOOCOVE an installer's dream. Lumen outputs are suitable for complete illumination of a room without downlights.

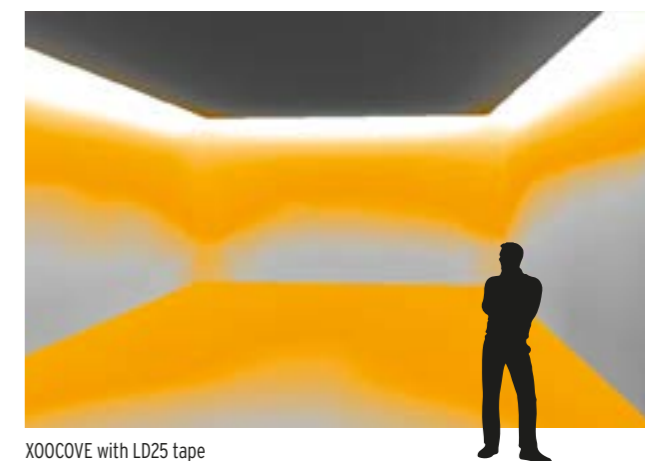

HYDRALUX™ IP67

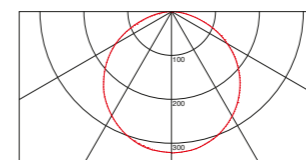

The only cuttable solution and outdoor rated cove light line amongst the 3 options. HYDRALUX™ provides sufficient ambient illumination and is very easy to install.

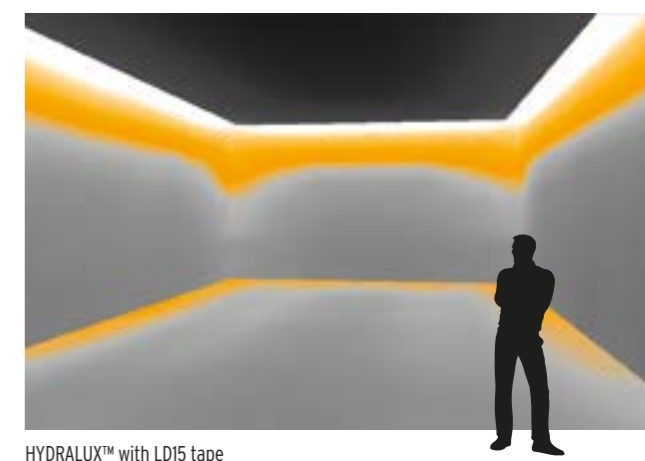

VarioContour 1924 & LUMINARIS ECO P23

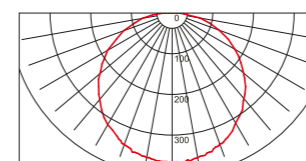

A simple solution using the cost effective LUMINARIS tape. VarioContour 1924 profile is a compact solution for large scale projects requiring standard cove light levels.

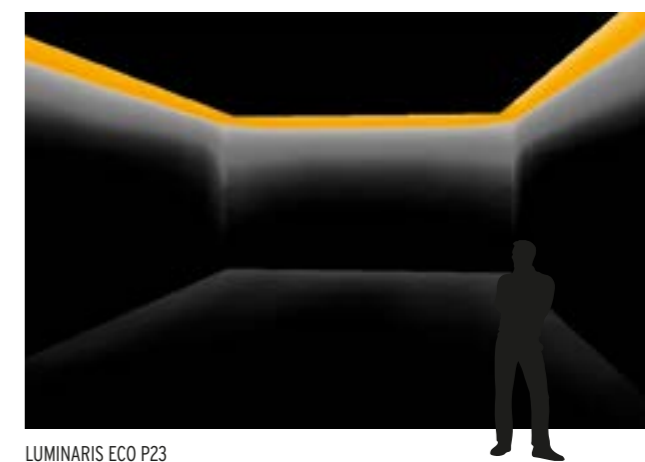

Room dimensions: 8 m x 5 m x 3 m (L x W x H)

Illuminances



LED Linear™ GmbH
Dr.-Alfred-Herrhausen-Allee 20
47228 Duisburg
Germany
Phone: +49 2065 94322-100
Fax: +49 2065 94322-120
info@led-linear.com

